



HT-BOX.COM
HUBERT PAPROCKI



**SELF-STORAGE
CONTAINERS**



Welcome to the HT-BOX.COM catalogue and we encourage You to familiarize Yourself with what we have to offer!

We are a dynamically growing family business based in Poland, EU.

For several years now we've been increasing sales in the European market by offering our own products and services, as well as assistance with investment projects.

Distinguished by high quality and professionalism, we are a pioneer in the production of Polish folding storage containers and proud to offer a wide range of products and services, while striving for a complete customer satisfaction. In addition to standard procurement assistance, our Client can also benefit from our vast expertise in the Self-Storage industry, from land arrangement to rental management, and everything in between.

As a company, we strive for the highest quality of products and a professional service in terms of loading, transportation, unloading and installation. **Connecting with HT-BOX.COM is not just buying a container. As an investor, You are gaining a Partner, access to our knowledge and experience, as well as an assistance with every aspect of the investment.**



Hubert Paprocki







M SERIES

Available colors:   







1,5M

 300 kg
  Width 2173 mm
  Length 1642 mm
  Height 2230 mm
  2 fitters ~30 min.







3M

 420 kg
  Width 2173 mm
  Length 3142 mm
  Height 2230 mm
  3 fitters ~45 min.







4,5M

 540 kg
  Width 2173 mm
  Length 4642 mm
  Height 2230 mm
  3 fitters ~60 min.



6M

 660 kg
  Width 2173 mm
  Length 6142 mm
  Height 2230 mm
  5 fitters ~60 min.





MB Series

Available colors:   







3MB (2 internal compartments)

External dimensions of the container:

 440 kg
  Width 2173 mm
  Length 3142 mm
  Height 2230 mm





Internal dimensions of each compartment:

 Width 1500 mm
  Length 2000 mm
  Height 2000 mm
  3 fitters ~45 min.







6MB/4 (4 internal compartments)

External dimensions of the container:

 820 kg
  Width 2173 mm
  Length 6142 mm
  Height 2230 mm





Internal dimensions of each compartment:

 Width 1500 mm
  Length 2000 mm
  Height 2000 mm
  5 fitters ~90 min.







4,5MB (3 internal compartments)

External dimensions of the container:

 620 kg
  Width 2173 mm
  Length 4642 mm
  Height 2230 mm





Internal dimensions of each compartment:

 Width 1500 mm
  Length 2000 mm
  Height 2000 mm
  4 fitters ~75 min.







6MB/6 (6 internal compartments)

External dimensions of the container:

 720 kg
  Width 2173 mm
  Length 6142 mm
  Height 2230 mm

Internal dimensions of each compartment:

 Width 990 mm
  Length 2000 mm
  Height 2000 mm
  5 fitters ~90 min.

MD Series

Available colors:   

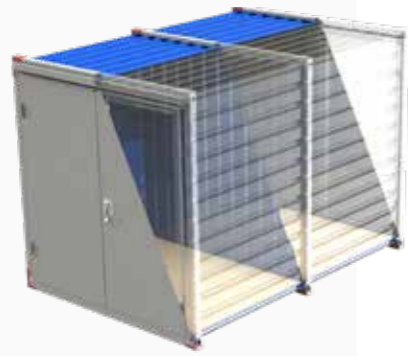

3MD (2 internal compartments)

External dimensions of the container:



Internal dimensions of each compartment:

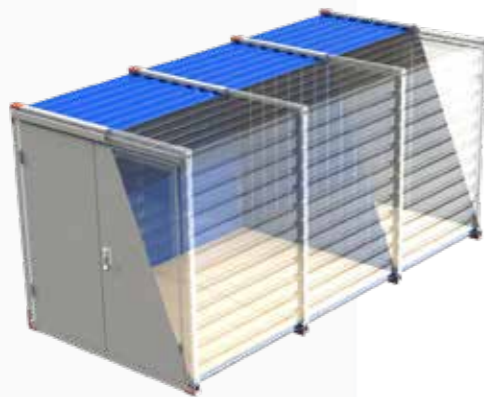
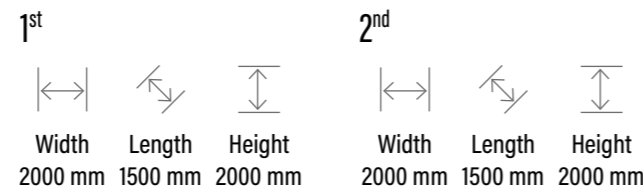

4,5MD (2 internal compartments)

External dimensions of the container:



Internal dimensions of each compartment:

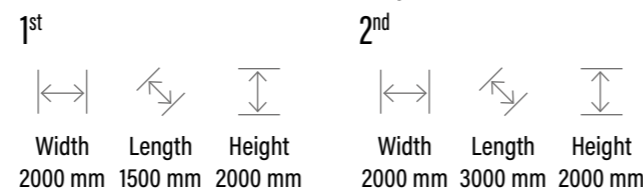

6MD (2 internal compartments)

External dimensions of the container:



Internal dimensions of each compartment:



MW Series



3MW



4,5MW



6MW

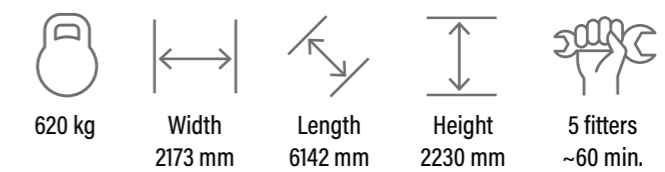

Hybrids



MHYB (2+ internal compartments)

HYBRID containers are a combination of all other series. Custom made to fit those irregular spaces and otherwise unfittable parts of the land.

Seria JB



JBOX 2.4

JBox 2.4 has been designed especially for our customers owning high bay storage warehouses as it sits on three Euro pallets. It has also gained popularity among garden owners, self-storage community, as well as backyard users due to its smaller size.

What makes it different from our other series?

- it sits on three Euro pallets perfectly and its solid construction allows for safe and secure storage of goods;
- the 32 mm tongue and groove joint floor has been reinforced to provide better stability of the entire box during movement;
- thanks to modern solutions, the hinges do not need to be adjusted after each move;
- 70mm high floor profiles allow for an easy transport by forklift;
- it is equipped with specially designed, 3mm thick corner plate horns which not only strengthen the structure of the whole container, but also allow for a transport by crane;



JB Series



JB2.4



220 kg



3 fitters
~45 min.



External dimensions:



Width
1150 mm



Length
2400 mm



Height
2230 mm

Internal dimensions:



Width
1020 mm



Length
2300 mm



Height
2070 mm



Call:

+48 790 211 600 or +48 504 322 402



GRGBOX 2.3

GRGBox 2.3 is a sensational solution for every garage or parking space owner. It will fit a lot of things that are not usually destined for storing at home like garage necessities, small sport equipment or even tires. Specially designed bracket is useful with chaining up a bicycle or a stroller. Additionally, the height of the base is adjustable allowing for the hood of any car to fit under the trunk of a box, which in turn helps using the whole space comfortably.

Product features

- Warranty: 2 years.
- Material: 1mm-2mm thick, galvanized steel sheet in 1st class.
- Triple bolt lock.
- Ergonomic handle for convenient opening and closing of the box.
- Adjustable height of the base facilitating the fit under the trunk of the box.
- Built-in levelling system.
- The flap equipped with two pneumatic cylinders for easy lifting.
- Included: two shelves and a bicycle / stroller bracket.
- Possibility of adding more accessories such as shelves or hooks.
- Load capacity: 400 kg.
- Capacity: 1.84 m3.
- Quick assembly with the help of a precise User Manual.



155 kg



2 fitters~15 min.

Dimensions:



Width
2280 mm



Length
900 mm



Height
1700 mm- 2100 mm

Trunk dimensions:



Width
2280 mm



Length
900 mm



Height
900 mm



Height (floor to base of the trunk)
800- 1200 mm

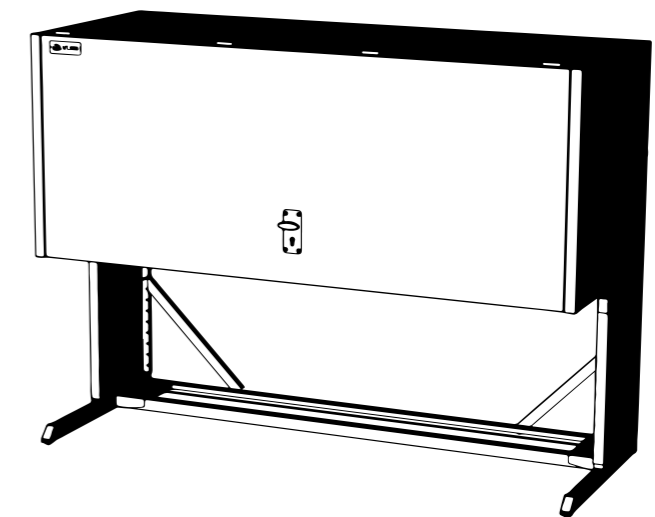

Doors



Specially reinforced door wings guarantee their high rigidity and safety.

Corners



3mm thick corner plate horns not only strengthen the structure of the whole container, but also allow for a transport by crane. The mandrels allow the containers to be stacked up.

Casement Bolt



Our self - designed locking system ensures easy operation and provides extra security.

Gutter



Innovatively designed gutter of increased capacity, equipped with a system against rainwater overflow.

Floor



Our containers are equipped with **impregnated**, 32 mm thick, tongue and groove joined floors.

Transport ready package



Our containers can be folded and stacked which saves space and reduces transport costs.

Loading / Unloading



70 mm floor profiles allow for a transport by forklift.

Stacking up



Innovative method of stacking containers up, allowing for additional storage area space.

CUSTOMIZATION

We offer custom color coating of elements, such as doors and corners which lets our customers stand out from the competition, but at the very least adds a unique character to their business.



Burglar-Proof Bar



Assembled at customer's request. Increases security against burglary.

Inclined Plane



Allows for an easier loading/unloading in and out of the container.

Upright Mast



Specially designed mast, perfect for attaching lights and monitoring cameras.

Staircase



The stairs and railing system.

Investment in the Self-Storage Industry



There are thousands of Self-Storage facilities currently operating in Europe, but the market is still hungry for this type of investments.

What makes it worthy of investing in Self-Storage?

For over a decade now, Self-Storage has been outperforming retail, office, apartment and industrial renting as storage spaces are mostly basic construction and cheaper than commercial real estate.

- Fast-growing industry
- High demand
- Passive income business model
- Low maintenance costs
- Opportunity for rapid growth and expansion
- High return rate

Investment components:

- Owned or leased land/facility/warehouse
- Site preparation
- Fencing of the property
- Gate and its authorization system installation
- Assembly of HT-BOX.COM storage containers
- Installation of a monitoring system
- Implementation of the IT management system - STORJAY.COM

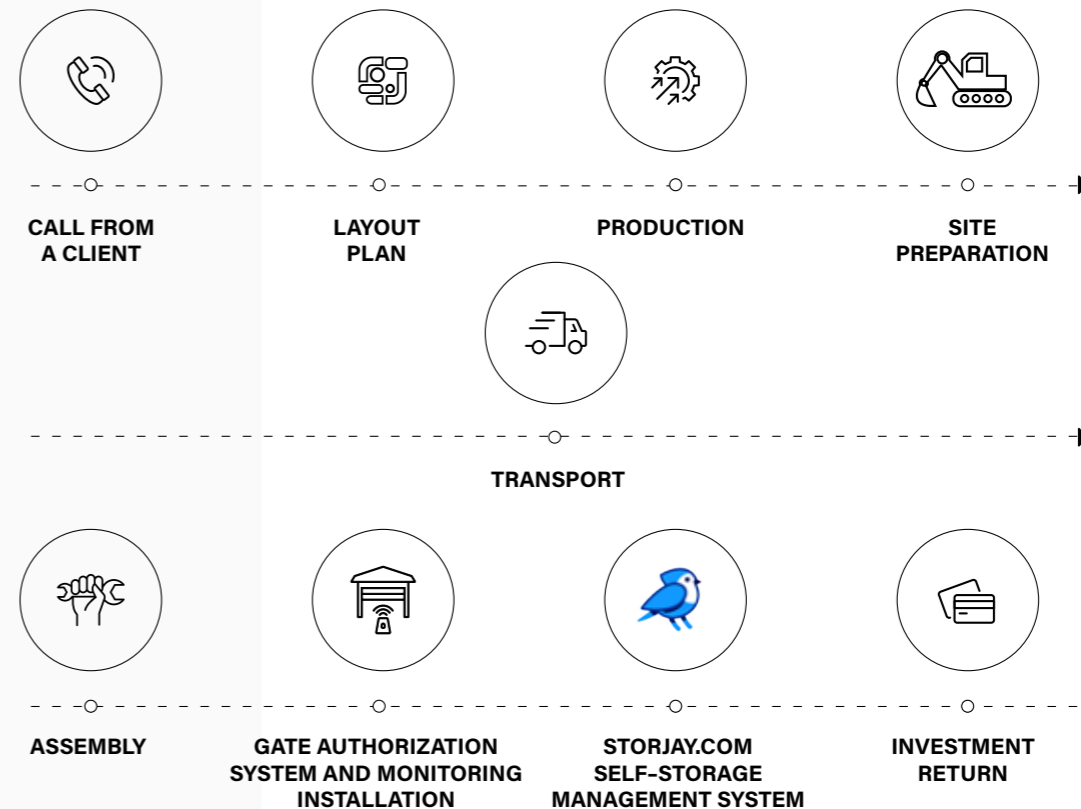

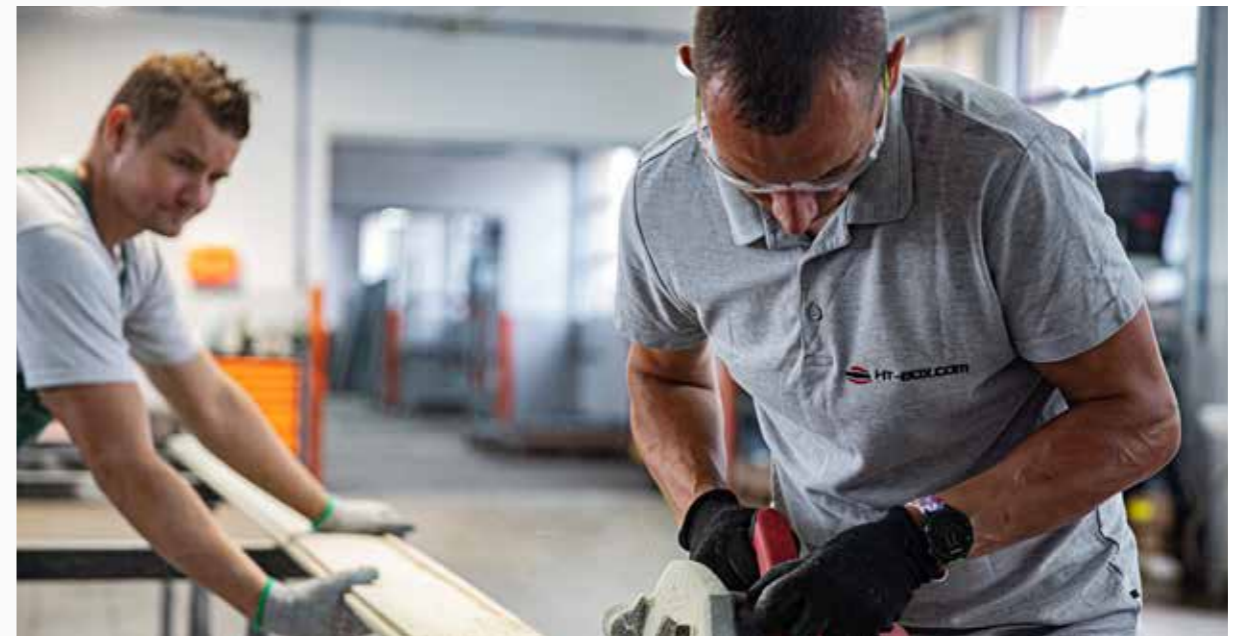

ASSEMBLY







SELF-STORAGE MANAGEMENT SYSTEM

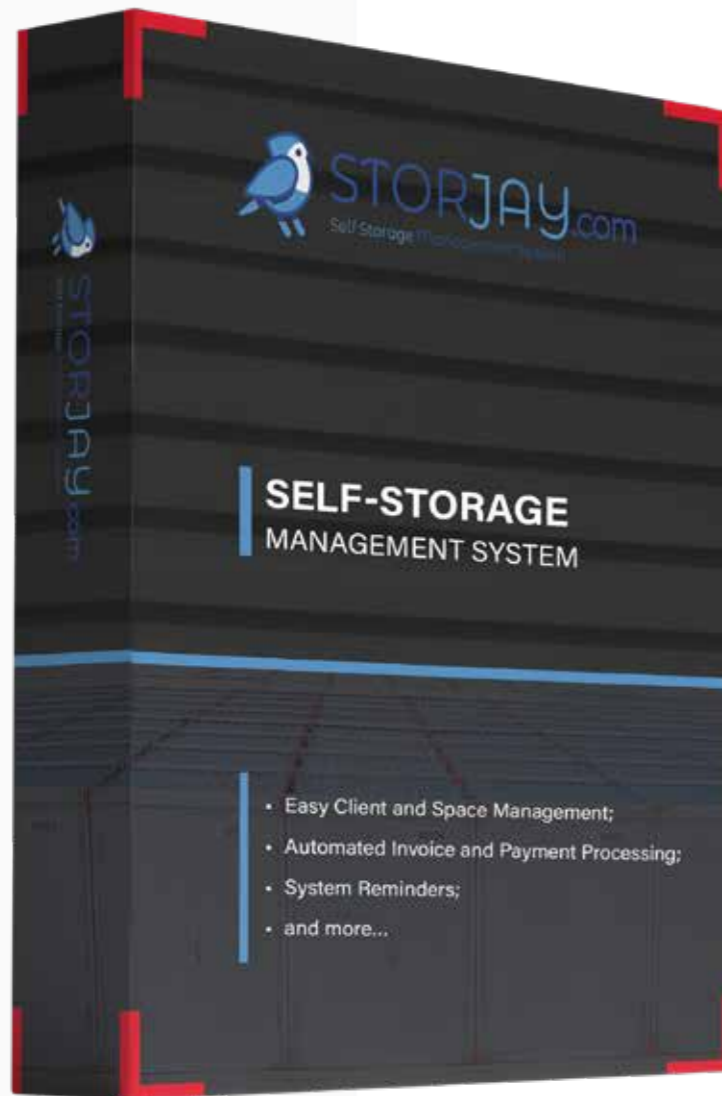

Designed and developed by us, **STORJAY.COM** software creates many possibilities in the field of container and storage space rental management. For more information, visit our website at www.storjay.com or contact us directly at: **+48 507 508 611**.

PROJECT SUPPORT

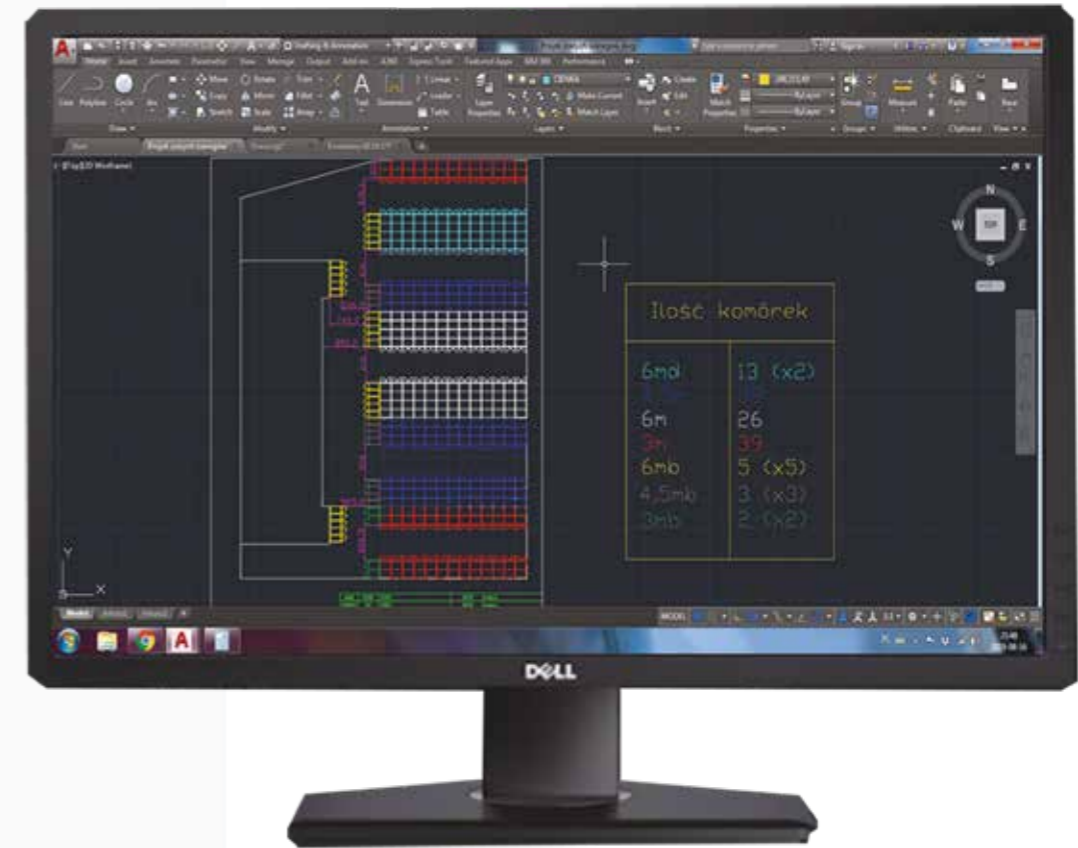

Knowing how difficult it is to imagine the final appearance of the project, we introduce a plot/facility arrangement service. Our team will help and suggest the optimal use of space and selection of appropriate containers for a specific location.

**USE OUR EXPERIENCE AND CALL TODAY:
+48 790 211 600 OR +48 504 322 402**



7

8

9

10

HT-BOX

HT-BOX.COM

HT-BOX

HT-BOX.COM



Rzeczpospolita
Polska



Unia Europejska
Europejski Fundusz
Rozwoju Regionalnego



HT-BOX.COM

UL. DRAWSKA 62D
78-300 ŚWIDWIN
POLAND

TEL.+48 790 211 600

TEL.+48 504 322 402

WWW.HT-BOX.COM